

BURNHAM®

Commercial Boilers

RATINGS AND DATA

Shell Diameter : 31 $\frac{1}{8}$ "
 Gross Output - BHP : 91.5
 Gross Output - MBH : 3064
 Gross Output - Lbs/Hr. : 3158
 Safety Valve - Lbs/Hr. : 3298

Heating Surface - Sq. Ft.
 Fireside - 348
 Firetubes
 Number - 86
 Diameter - 2" O.D.

Firing Rate
 1000 BTU Gas (MBH) - 3674
 140000 BTU/Gal Oil (GPH) - 25.3

Water Content
 Pounds - 3200
 Gallons (U.S.) - 384
 Approximate Weight/LBS.
 Dry - 5900
 Wet - 9100

LEGEND CONNECTIONS

- A = 6" FLANGED SUPPLY (300#)
- B = 3" RETURN
- C = 2" WASHOUT
- D = 1" WATER COLUMN
- E = 3/4" AQUASTAT
- F = 1-1/2" BOTTOM BLOWDOWN
- G = 3 X 4 HANDHOLE
- H = 1-1/2" AUXILIARY CONNECTION
- J = 2" SAFETY VALVE
- K = 12" NOMINAL FLUE DIAMETER
- L = 1-1/2" SURFACE BLOWOFF

LEGEND

BS = BOTH SIDES
 RS = RIGHT SIDE

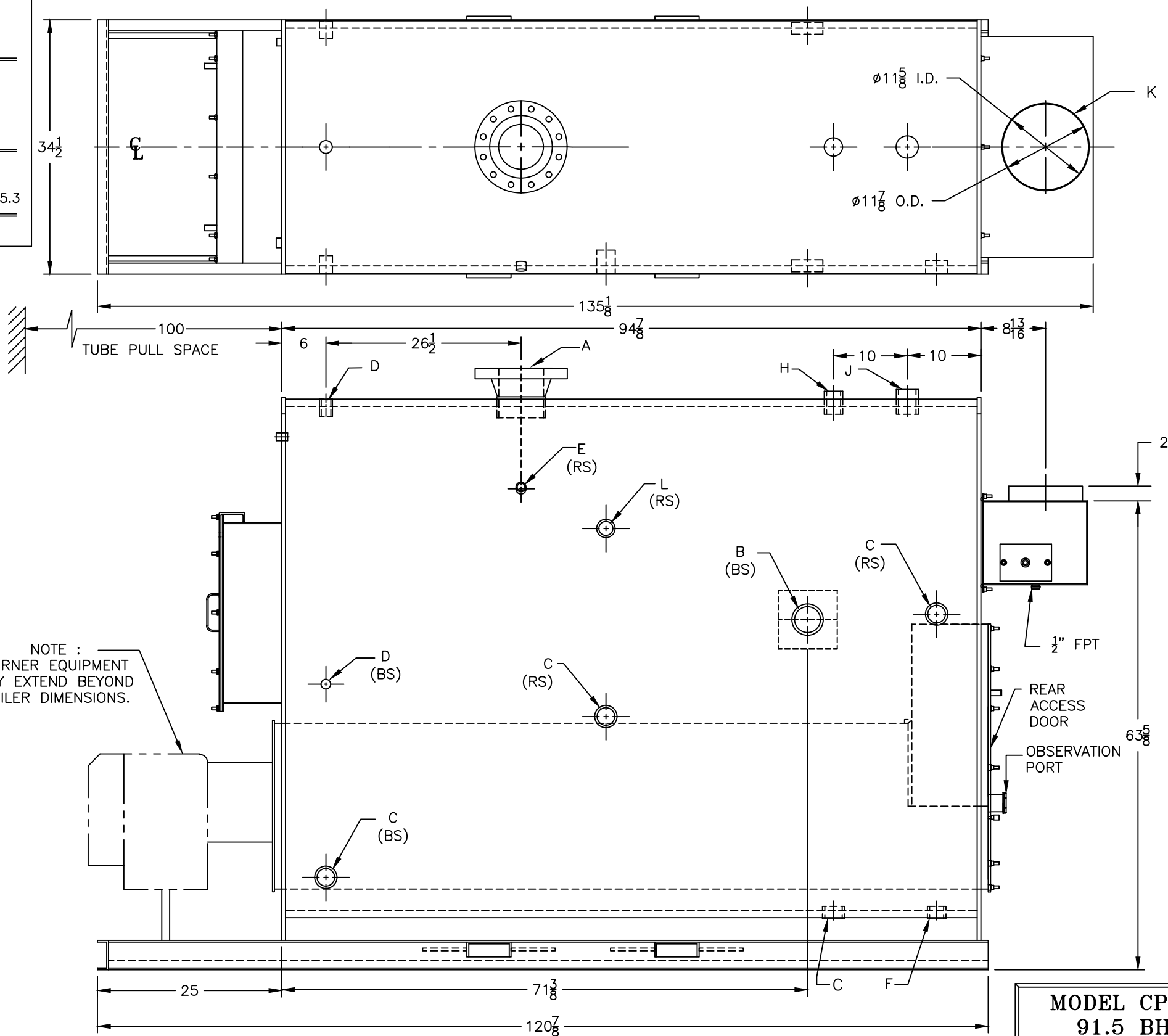
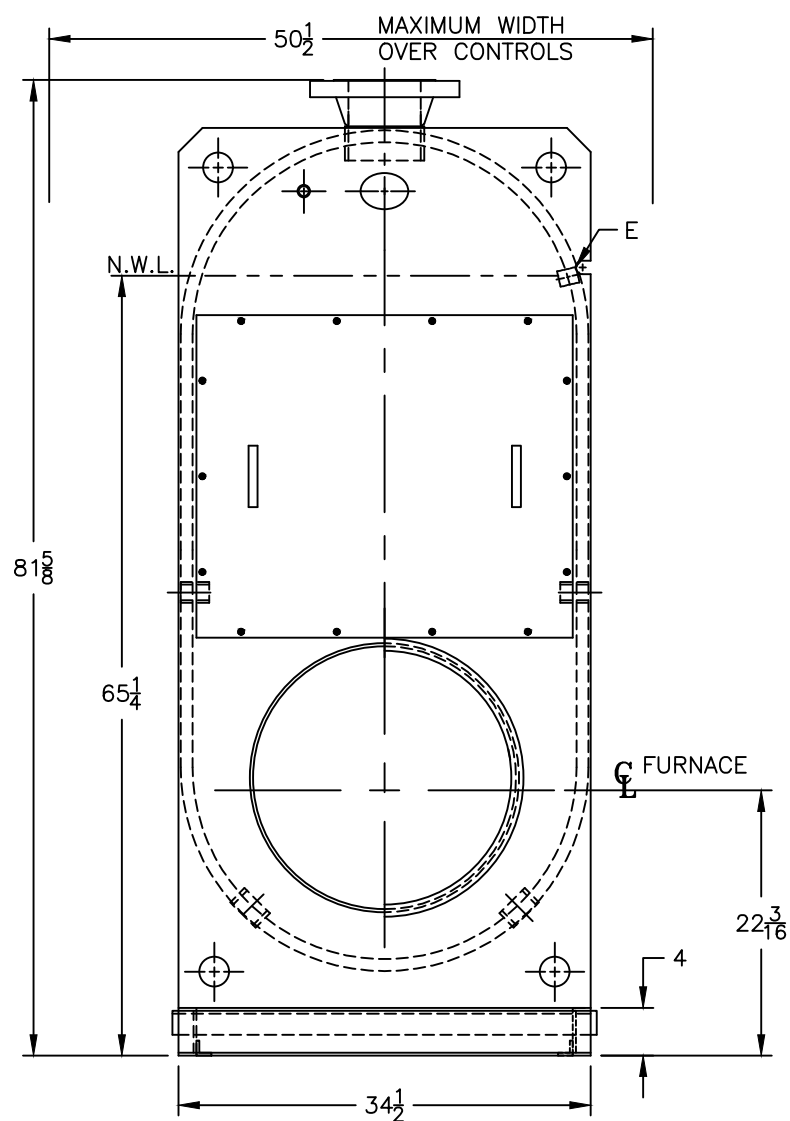

NOTE :
 BURNER EQUIPMENT
 MAY EXTEND BEYOND
 BOILER DIMENSIONS.

SPECIFICATIONS SUBJECT TO CHANGE WITHOUT NOTICE
 ALL CONNECTIONS ARE THREADED UNLESS OTHERWISE SPECIFIED

MODEL CP-90
91.5 BHP
30 PSI STEAM