

BURNHAM®

Commercial Boilers

LEGEND CONNECTIONS

- A = 6" FLANGED SUPPLY (150#)
- B = 4" RETURN
- C = 3" x 4" HANDHOLE
- D = 1" WATER COLUMN
- E = 3/4" AQUASTAT
- F = 1-1/2" SURFACE BLOWOFF/WASHOUT
- G = 1/2" TEMPERATURE GAUGE
- H = 1-1/2" SAFETY/RELIEF VALVE
- J = 1" AUXILIARY CONNECTION
- K = 10" NOMINAL FLUE DIAMETER

RATINGS AND DATA

Shell Diameter : 33 $\frac{1}{8}$ "

Heating Surface - Sq. Ft.
 Fireside - 194
 Waterside - 209

Firetubes
 Number - 61
 Diameter - 2" O.D.

Furnace
 Volume (Cubic Feet) - 29.1

Water Content
 Steam - 187 Gal. (U.S.)
 Water - 257 Gal. (U.S.)

Approximate Weight (Lb.)
 Dry - 3600
 Wet (Steam) - 5155
 Wet (Water) - 5745

LEGEND

- BS = BOTH SIDES
- RS = RIGHT SIDE
- LS = LEFT SIDE
- FB = FRONT OF BOILER
- RB = REAR OF BOILER

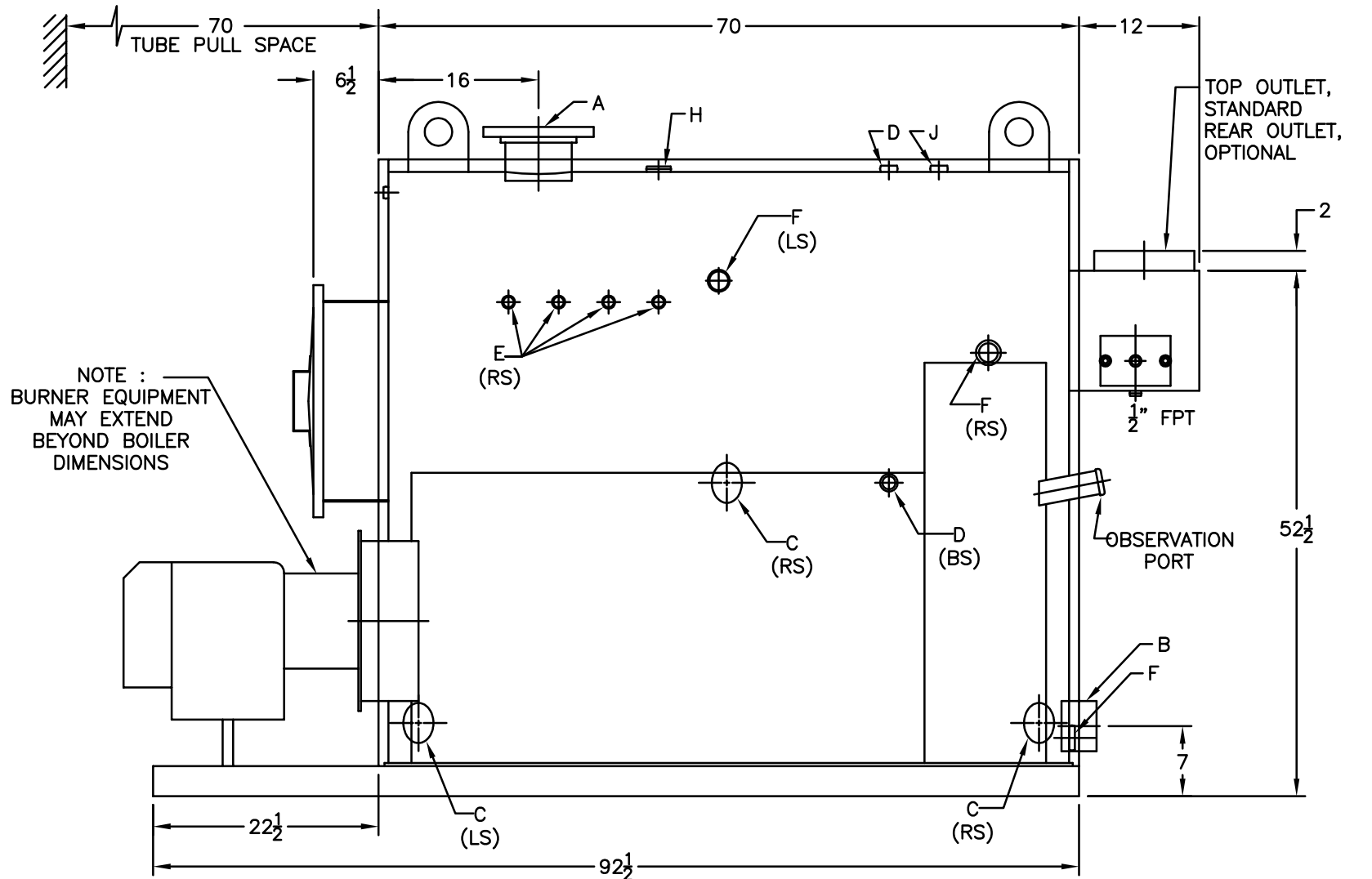
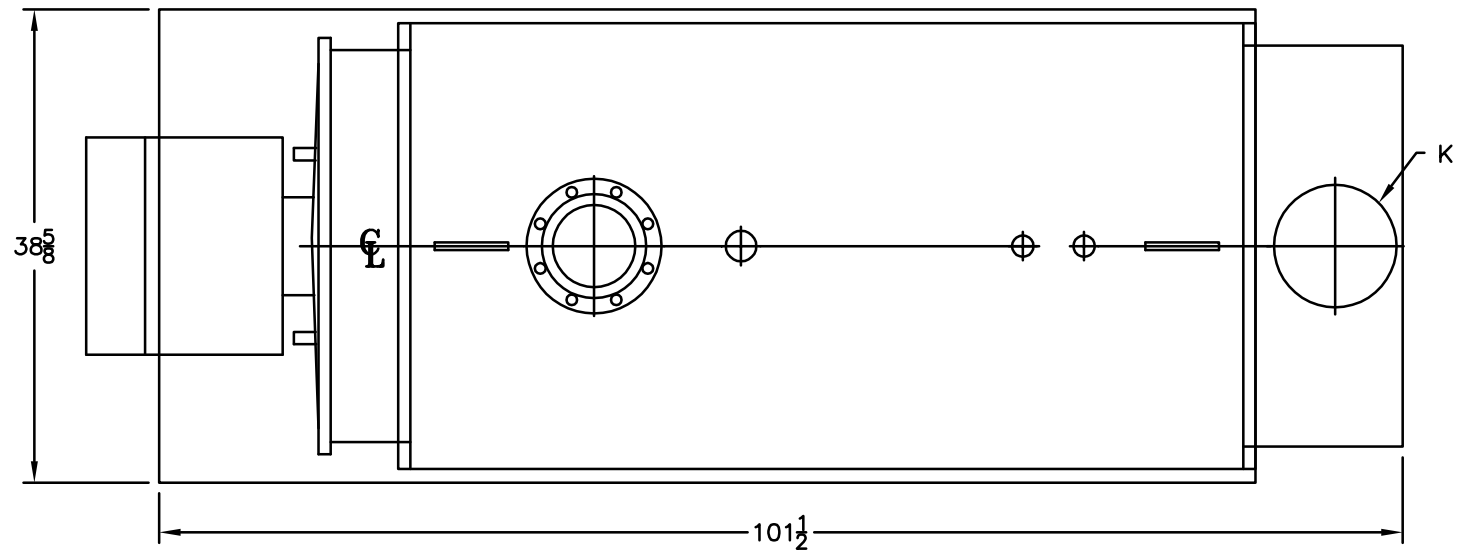
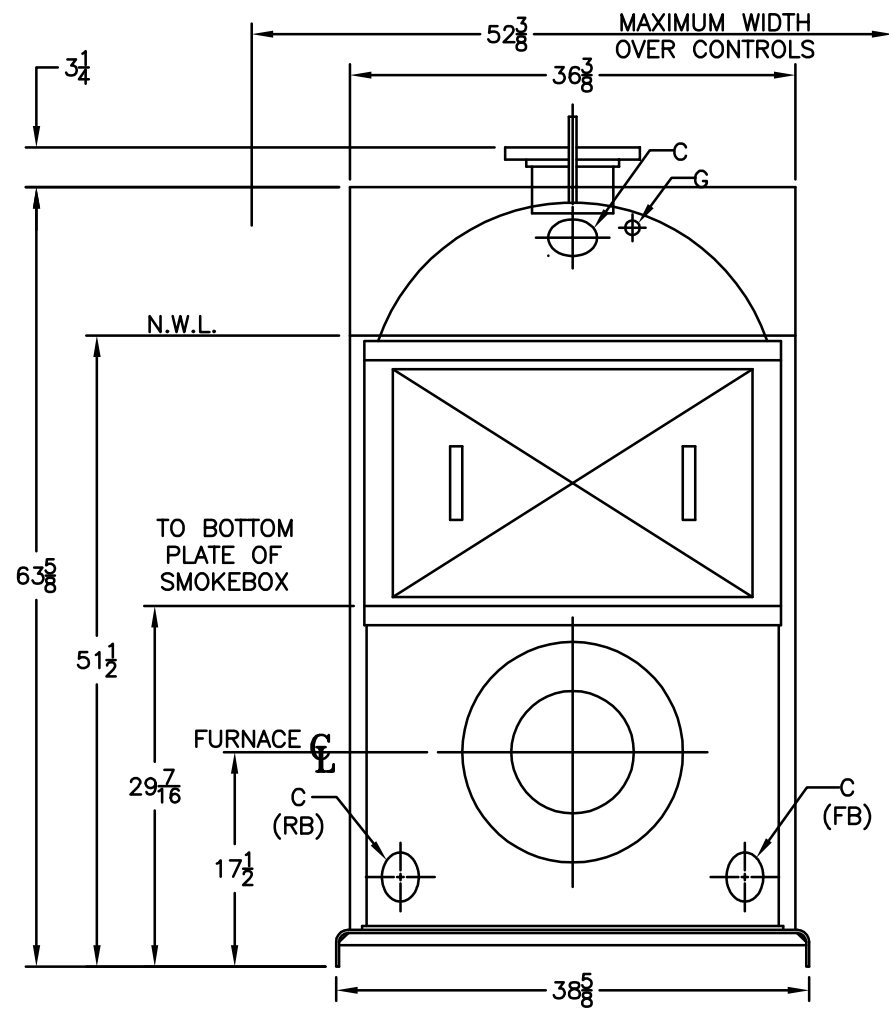

SPECIFICATIONS SUBJECT TO CHANGE WITHOUT NOTICE ALL CONNECTIONS ARE THREADED UNLESS OTHERWISE SPECIFIED
 THIS DOCUMENT CONTAINS CONFIDENTIAL INFORMATION WHICH IS THE PROPERTY OF BURNHAM COMMERCIAL. THIS DOCUMENT MAY NOT BE REPRODUCED, TRANSFERRED OR USED, OR ITS CONTENTS DISCLOSED, WITHOUT THE WRITTEN PERMISSION OF THE OWNER.

MODEL 4F-209

MAY 2015 TS-3-8-2