

TOP VIEW

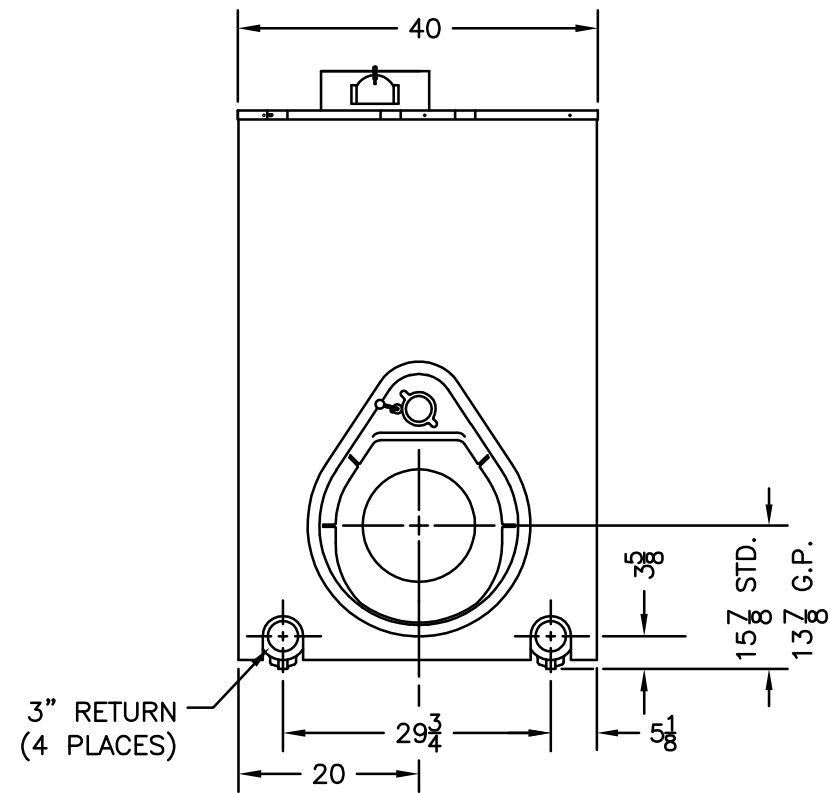

FRONT VIEW

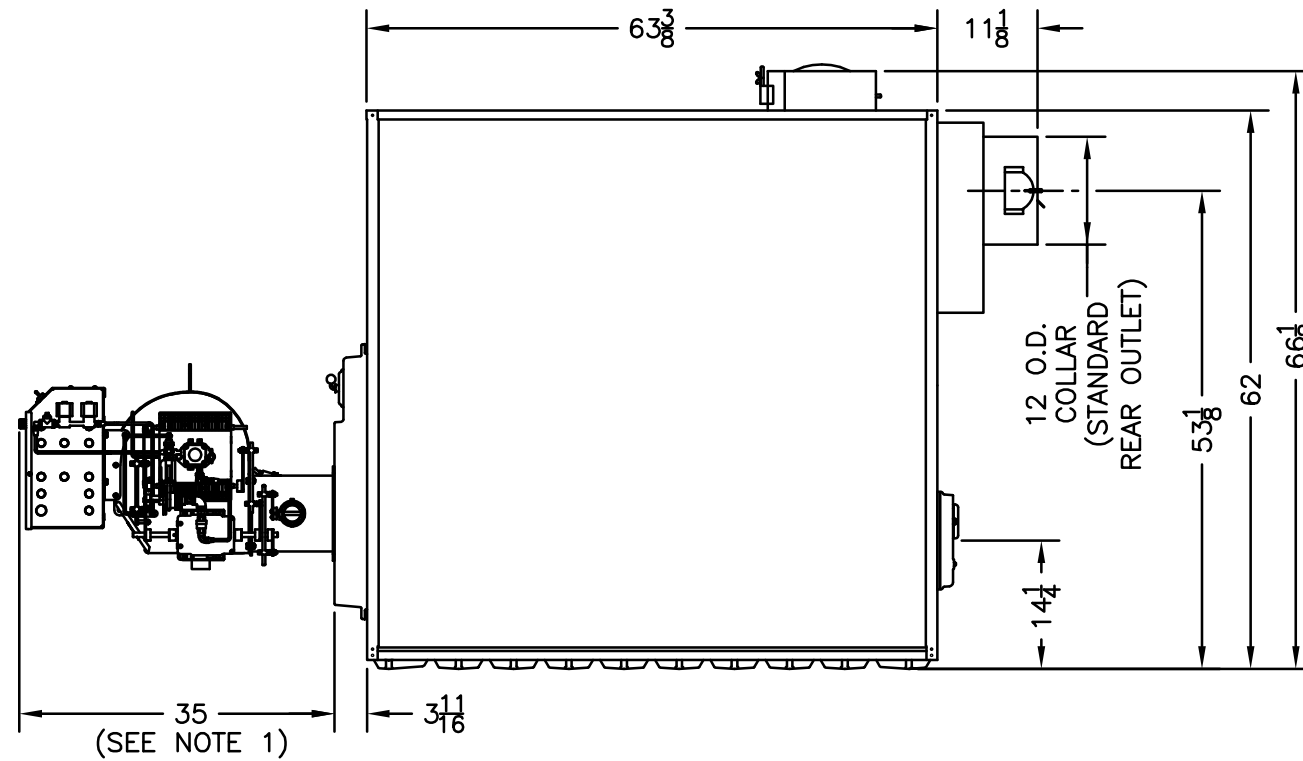

RIGHT SIDE VIEW
(BURNER INSTALLED)

NOTES:

1. TYPICAL POWER FLAME 'CR' BURNER LENGTH SHOWN. EXACT BURNER DIMENSIONS MAY VARY.
2. SPECIFICATIONS SUBJECT TO CHANGE WITHOUT NOTICE.

DIMENSIONS IN INCHES, FRACTIONAL TOLERANCES $\pm 1/32"$, ANGULAR TOLERANCES $\pm 1'$, UNLESS OTHERWISE NOTED.			SUPERSEDES			DWG. DATE 12/22/08
			DRAWING TITLE			DRAWING NO.
			DIMENSIONAL DRAWING V1110 WATER BOILER 20°F OR 40°F TEMPERATURE RISE			TS-93-70-B
DRAWN EAB	CHECKED	DESIGNED	APPROVED MZ	RELEASED	DWG. SCALE 3/64"=1"	REV. LEVEL