

TOP VIEW

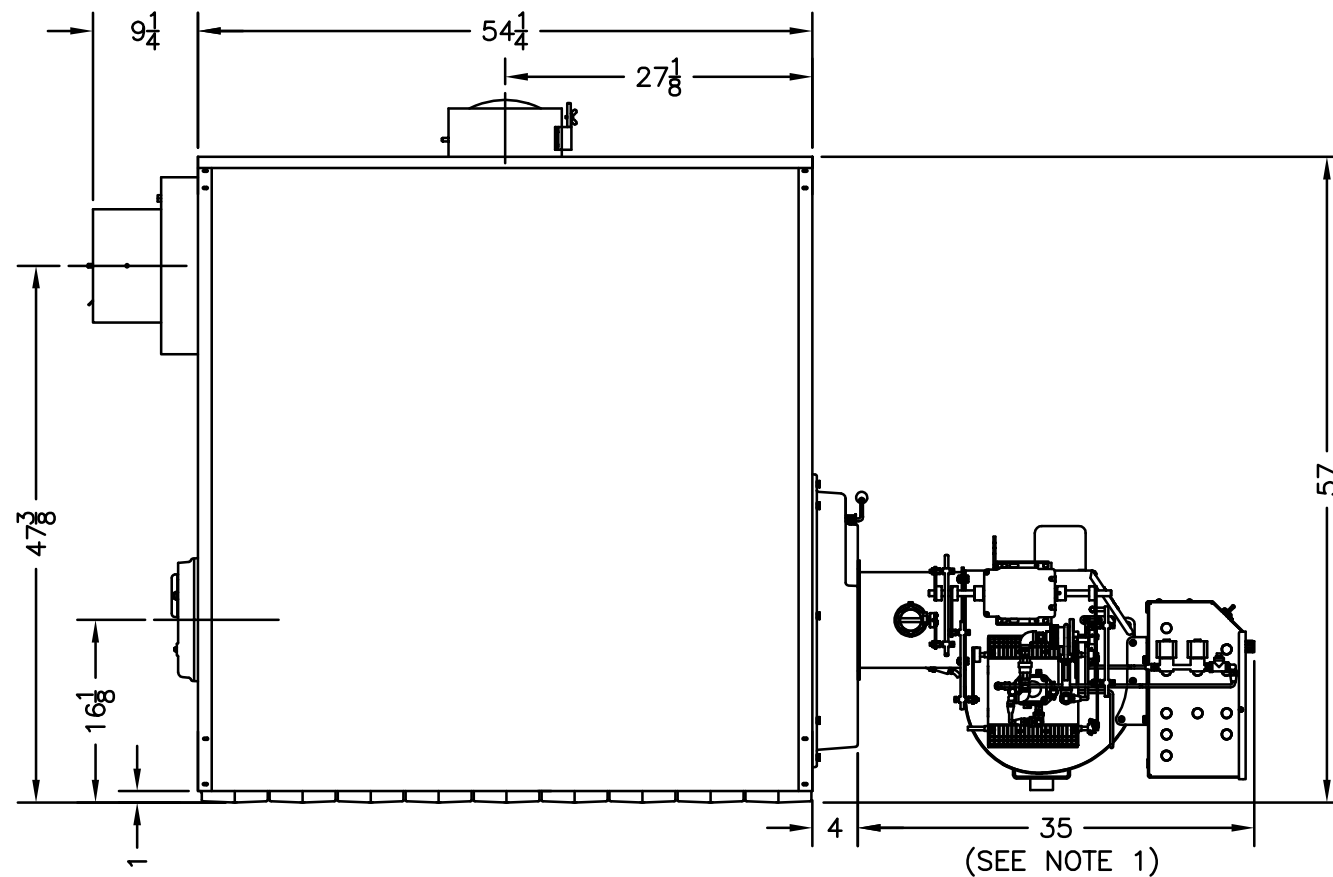

LEFT SIDE VIEW
(BURNER INSTALLED)

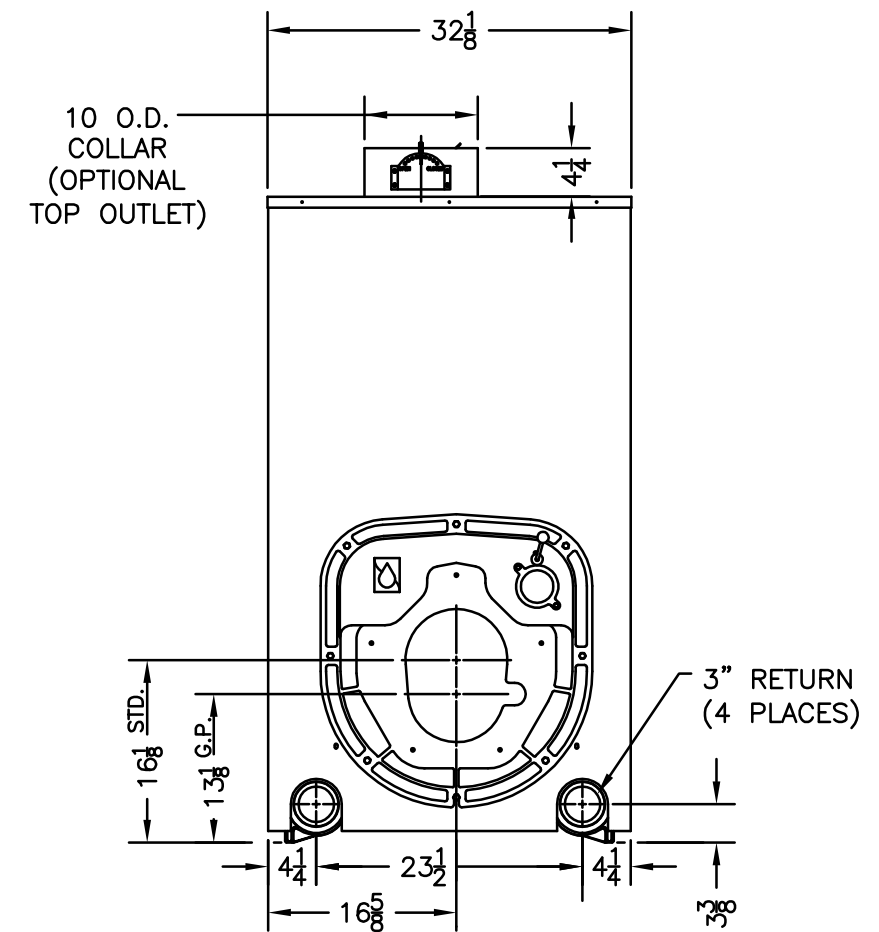

FRONT VIEW

- NOTES:
1. TYPICAL POWERFLAME 'C' BURNER LENGTH SHOWN. EXACT BURNER DIMENSIONS MAY VARY.
 2. SPECIFICATIONS SUBJECT TO CHANGE WITHOUT NOTICE.

DIMENSIONS IN INCHES, FRACTIONAL TOLERANCES $\pm 1/32"$, ANGULAR TOLERANCES $\pm 1^\circ$, UNLESS OTHERWISE NOTED.			SUPERSEDES			DWG. DATE 12/17/08
			DRAWING TITLE			DRAWING NO.
			DIMENSIONAL DRAWING V909A WATER BOILER 20°F OR 40°F TEMPERATURE RISE			TS-91-227-B
DRAWN EAB	CHECKED	DESIGNED	APPROVED RLW	RELEASED	DWG. SCALE 1/16"=1"	REV. LEVEL