

TOP VIEW

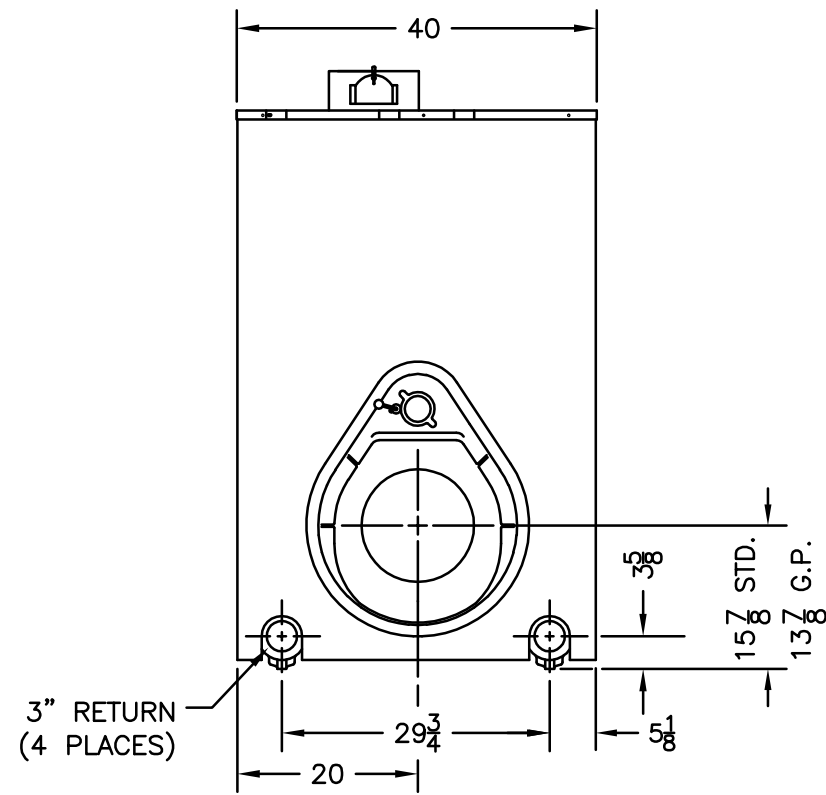

FRONT VIEW

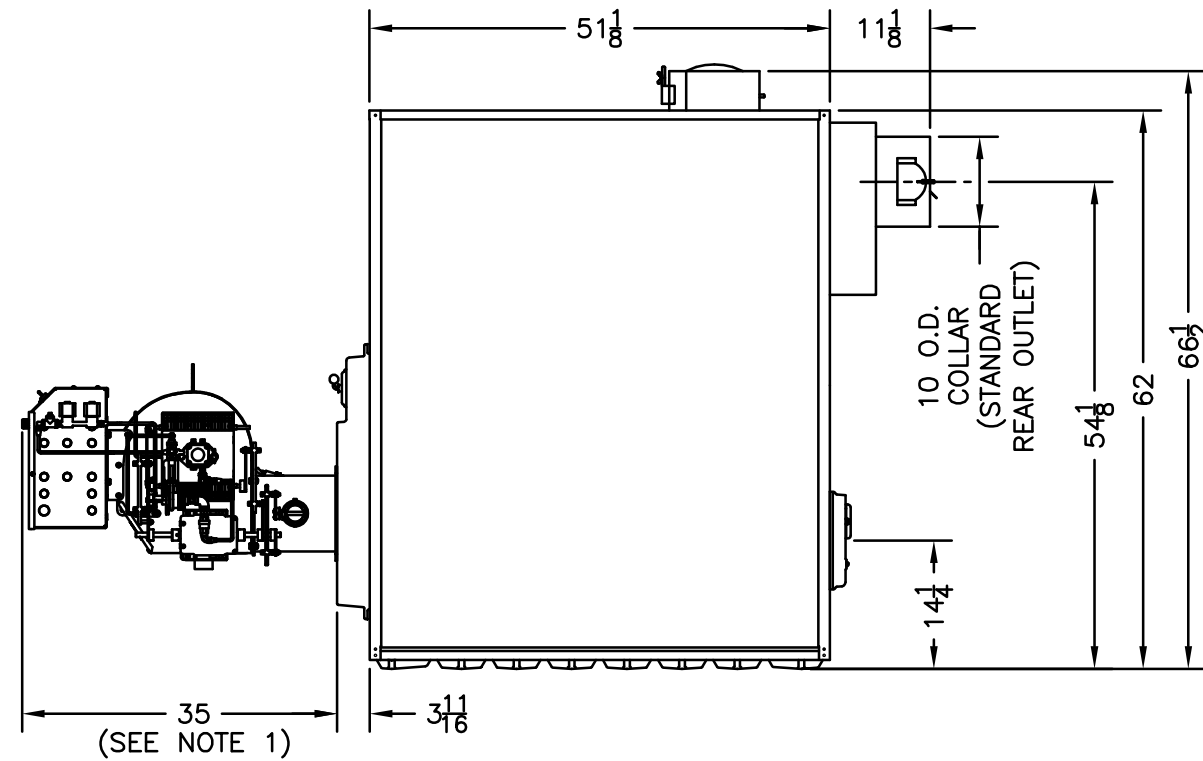

RIGHT SIDE VIEW
(BURNER INSTALLED)

NOTES:

1. TYPICAL POWER FLAME 'CR' BURNER LENGTH SHOWN. EXACT BURNER DIMENSIONS MAY VARY.
2. SPECIFICATIONS SUBJECT TO CHANGE WITHOUT NOTICE.

DIMENSIONS IN INCHES, FRACTIONAL TOLERANCES $\pm 1/32"$, ANGULAR TOLERANCES $\pm 1'$, UNLESS OTHERWISE NOTED.			SUPERSEDES		DWG. DATE 12/19/08	
BURNHAM [®] Commercial Boilers			DRAWING TITLE DIMENSIONAL DRAWING V1108 STEAM BOILER		DRAWING NO. TS-93-48-B	
			DRAWN EAB	CHECKED	DESIGNED	APPROVED MZ