

TOP VIEW

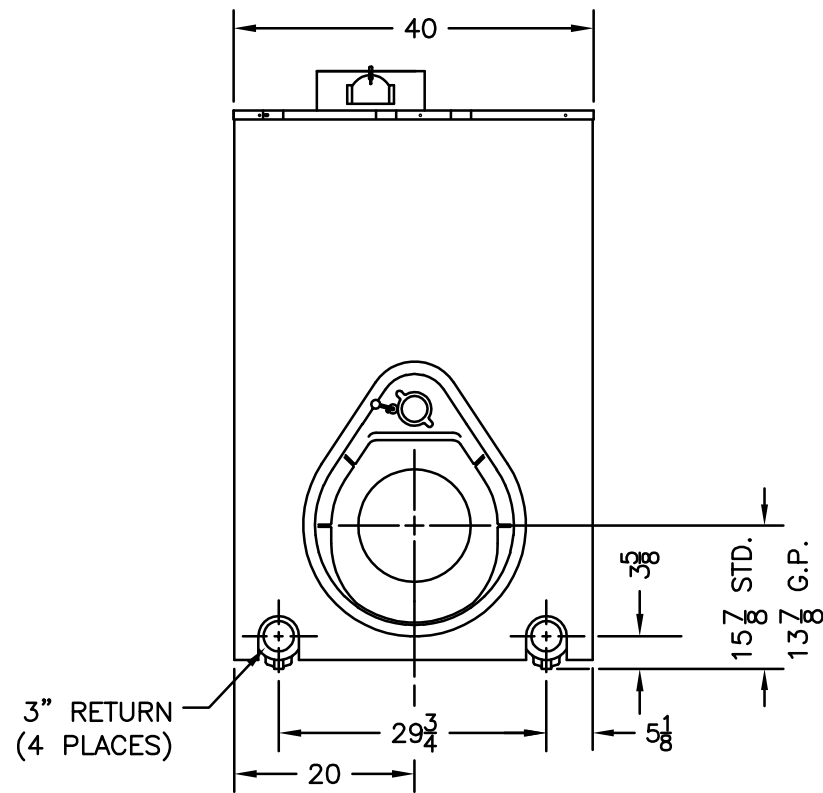

FRONT VIEW

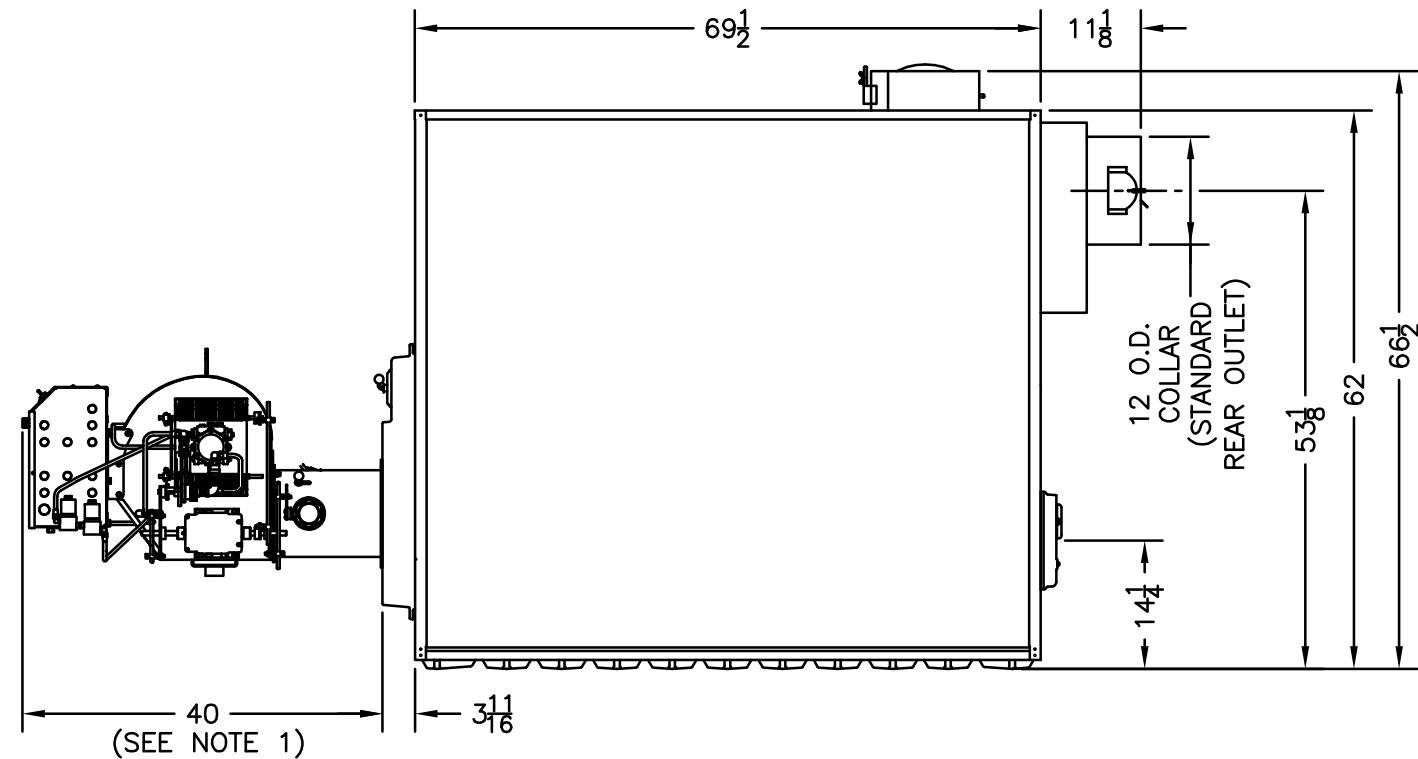

RIGHT SIDE VIEW  
(BURNER INSTALLED)

- NOTES:
1. TYPICAL POWER FLAME 'CR' BURNER LENGTH SHOWN. EXACT BURNER DIMENSIONS MAY VARY.
  2. SPECIFICATIONS SUBJECT TO CHANGE WITHOUT NOTICE.

DIMENSIONS IN INCHES, FRACTIONAL TOLERANCES $\pm 1/32"$ , ANGULAR TOLERANCES $\pm 1'$ , UNLESS OTHERWISE NOTED.			SUPERSEDES		DWG. DATE 12/22/08	
<b>BURNHAM</b> <sup>®</sup> Commercial Boilers			DRAWING TITLE DIMENSIONAL DRAWING V1111 WATER BOILER 20°F OR 40°F TEMPERATURE RISE		DRAWING NO. TS-93-71-B	
			DRAWN EAB	CHECKED	DESIGNED	APPROVED MZ