

# BURNHAM®

## Commercial Boilers

### RATINGS AND DATA

Shell Diameter : 70"  
 Gross Output - BHP : 186.4  
 Gross Output - MBH : 6239  
 Net Rating - MBH : 5425  
 Safety Valve - Lbs/Hr. : 7000

Heating Surface - Sq. Ft.  
 Fireside - 875  
 Firetubes  
 Number - 120  
 Diameter - 2.5" O.D.

Firing Rate  
 1000 BTU Gas (MBH) - 7323  
 140000 BTU/Gal Oil (GPH) - 50.6  
 150000 BTU/Gal Oil (GPH) - 47.2

Water Content  
 Pounds - 11584  
 Gallons (U.S.) - 1389  
 Approximate Weight/LBS.  
 Dry - 12379  
 Wet - 23963

### LEGEND CONNECTIONS

- A = 6" FLANGED SUPPLY (150#)
- B = 6" FLANGED RETURN (150#)
- C = 3" x 4" HANDHOLE
- D = 1" WATER COLUMN
- E = 3/4" AQUASTAT
- F = 2" BOTTOM DRAIN
- G = 2" AUXILIARY
- H = 3/4" GAUGE CONNECTION
- J = 1-1/2" RELIEF VALVE
- 2" RELIEF VALVE
- K = 12" X 16" MANHOLE
- L = 16" NOMINAL FLUE DIAMETER

### LEGEND

- BS = BOTH SIDES
- RS = RIGHT SIDE

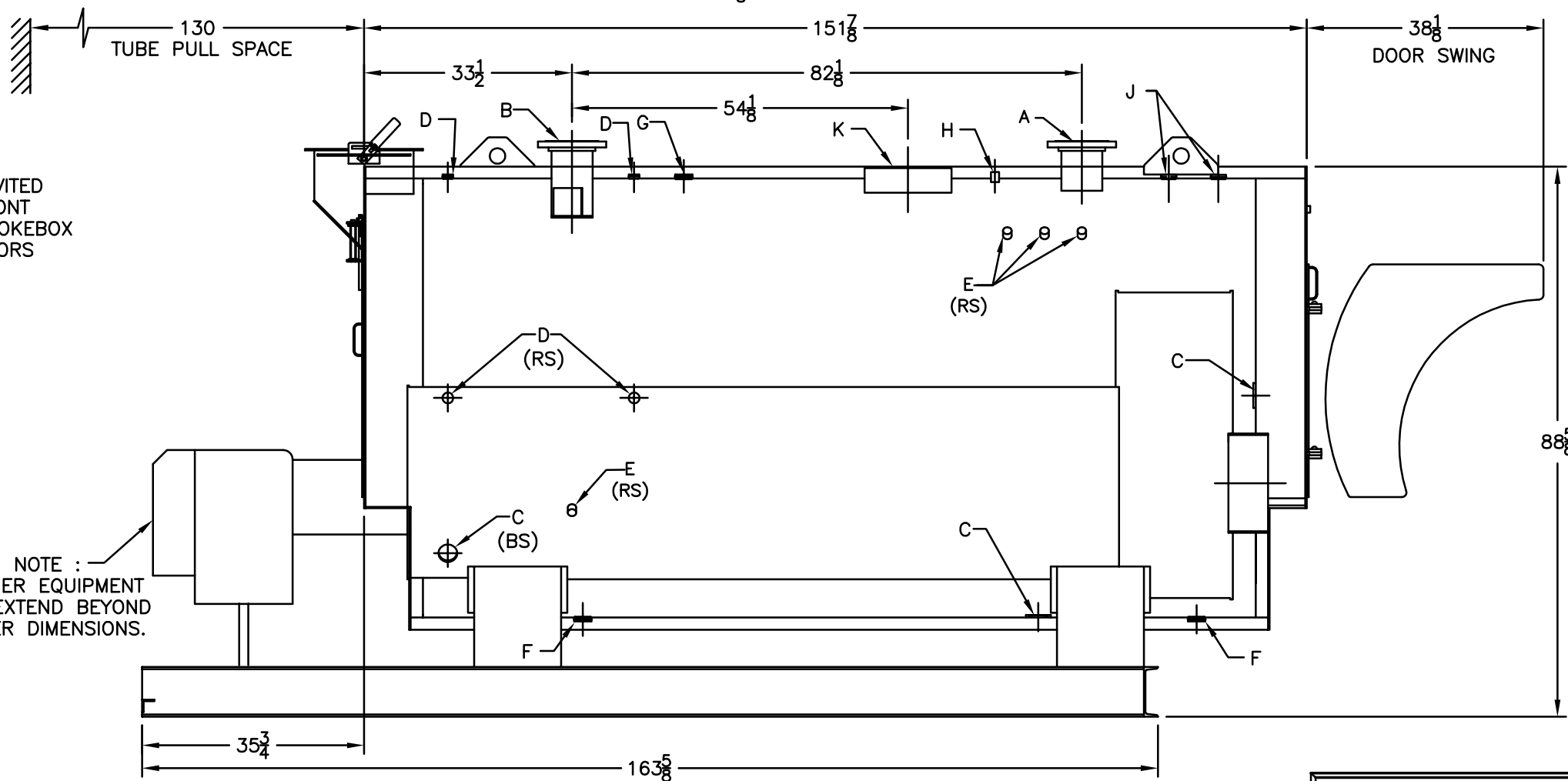
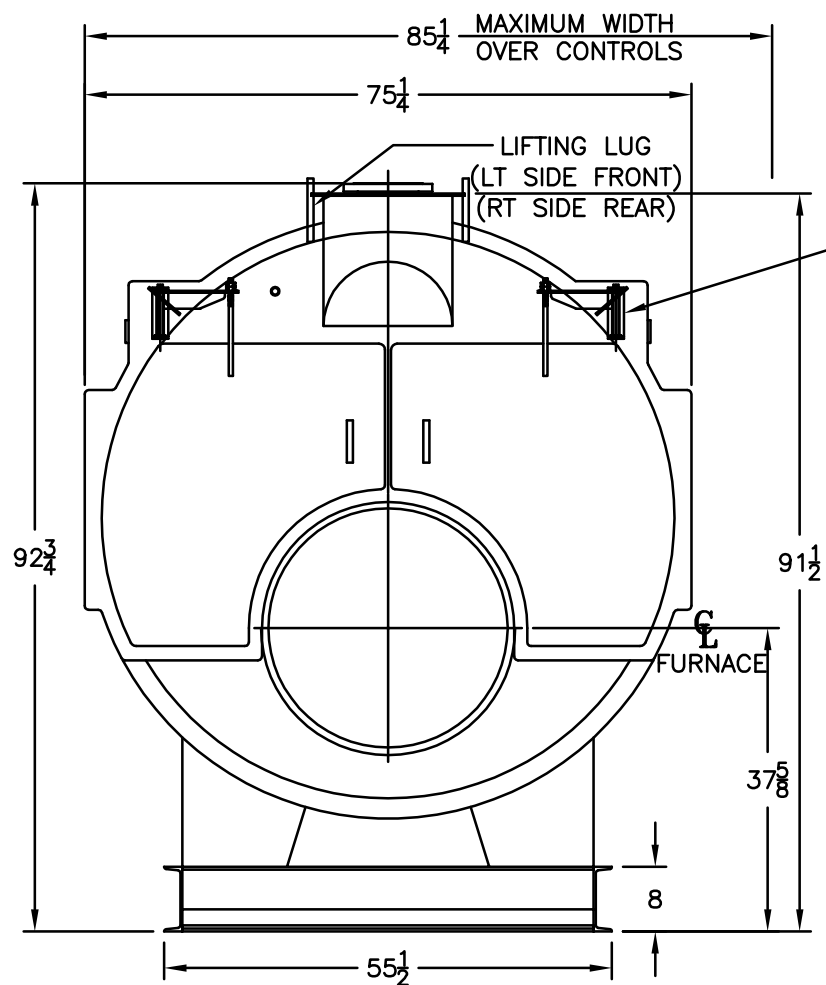
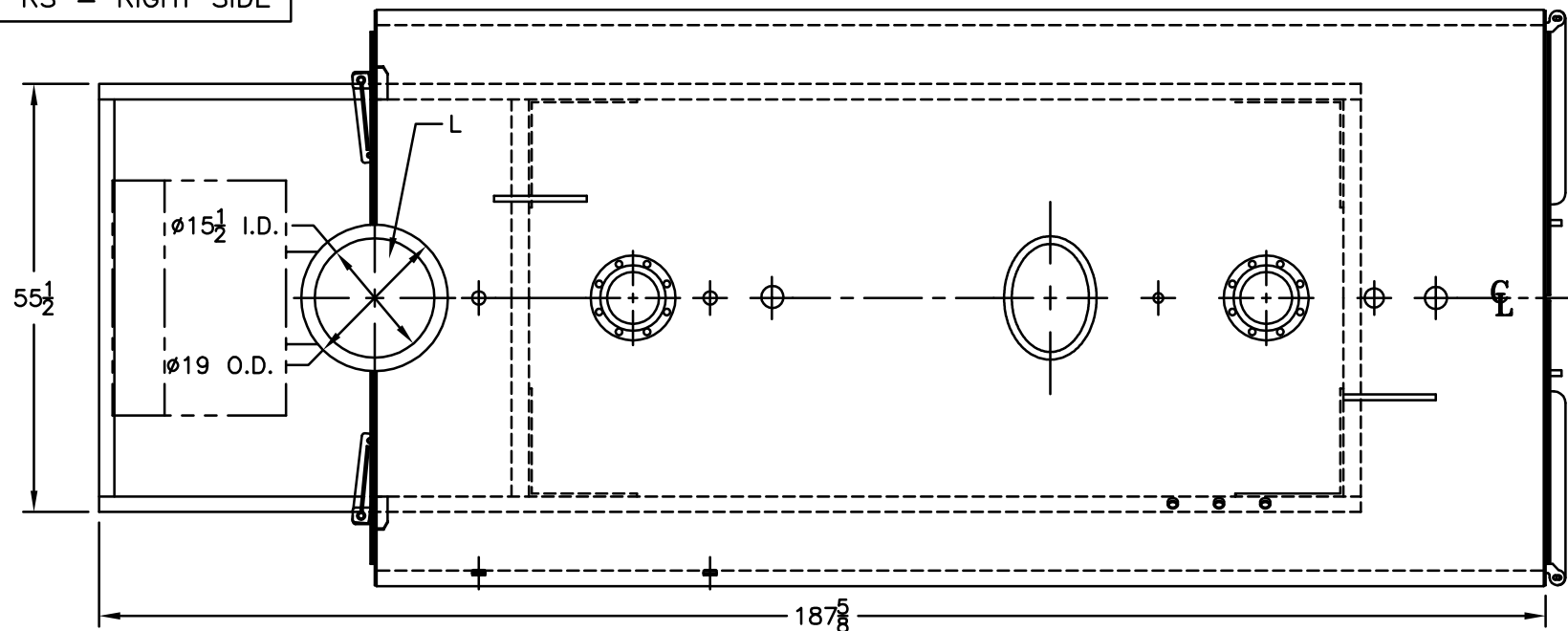

NOTE :  
 BURNER EQUIPMENT  
 MAY EXTEND BEYOND  
 BOILER DIMENSIONS.

**MODEL 4SW-175**  
**186.4 BHP**  
**30 PSI WATER**

SPECIFICATIONS SUBJECT TO CHANGE WITHOUT NOTICE ALL CONNECTIONS ARE THREADED UNLESS OTHERWISE SPECIFIED  
 THIS DOCUMENT CONTAINS CONFIDENTIAL INFORMATION WHICH IS THE PROPERTY OF BURNHAM COMMERCIAL. THIS DOCUMENT MAY NOT BE REPRODUCED, TRANSFERRED OR USED, OR ITS CONTENTS DISCLOSED, WITHOUT THE WRITTEN PERMISSION OF THE OWNER.