

TOP VIEW

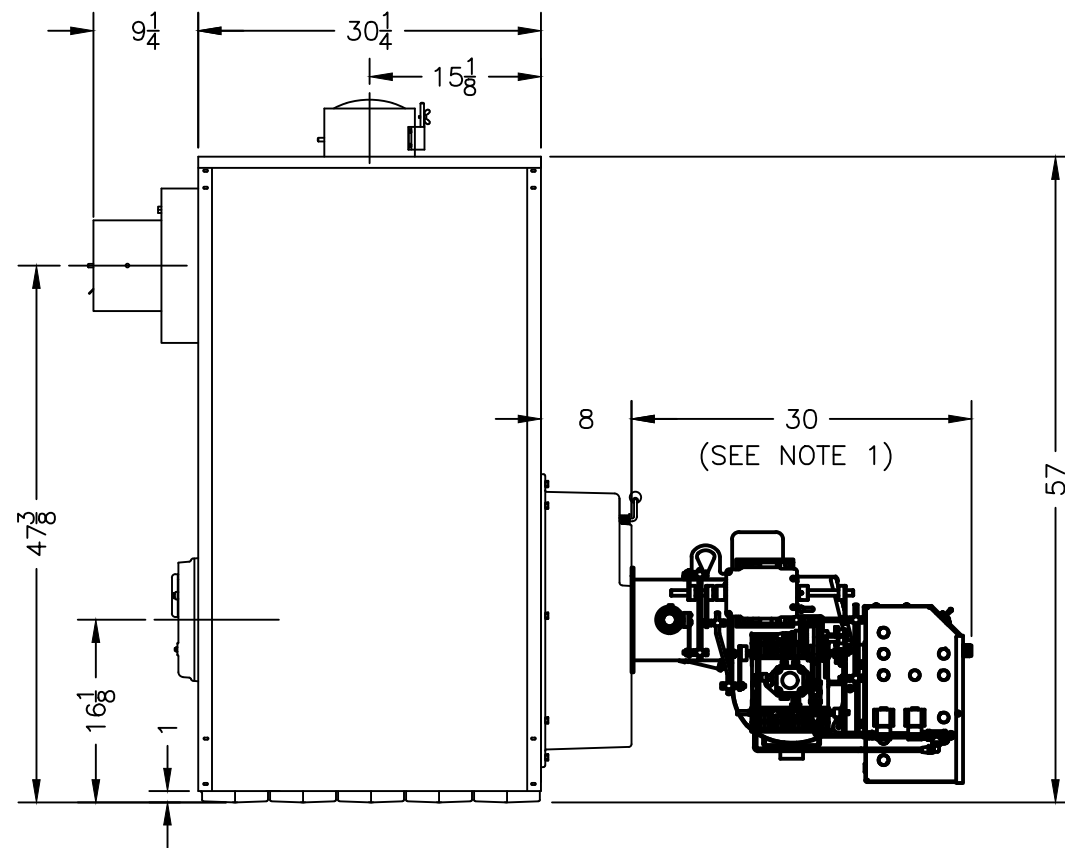

LEFT SIDE VIEW
(BURNER INSTALLED)

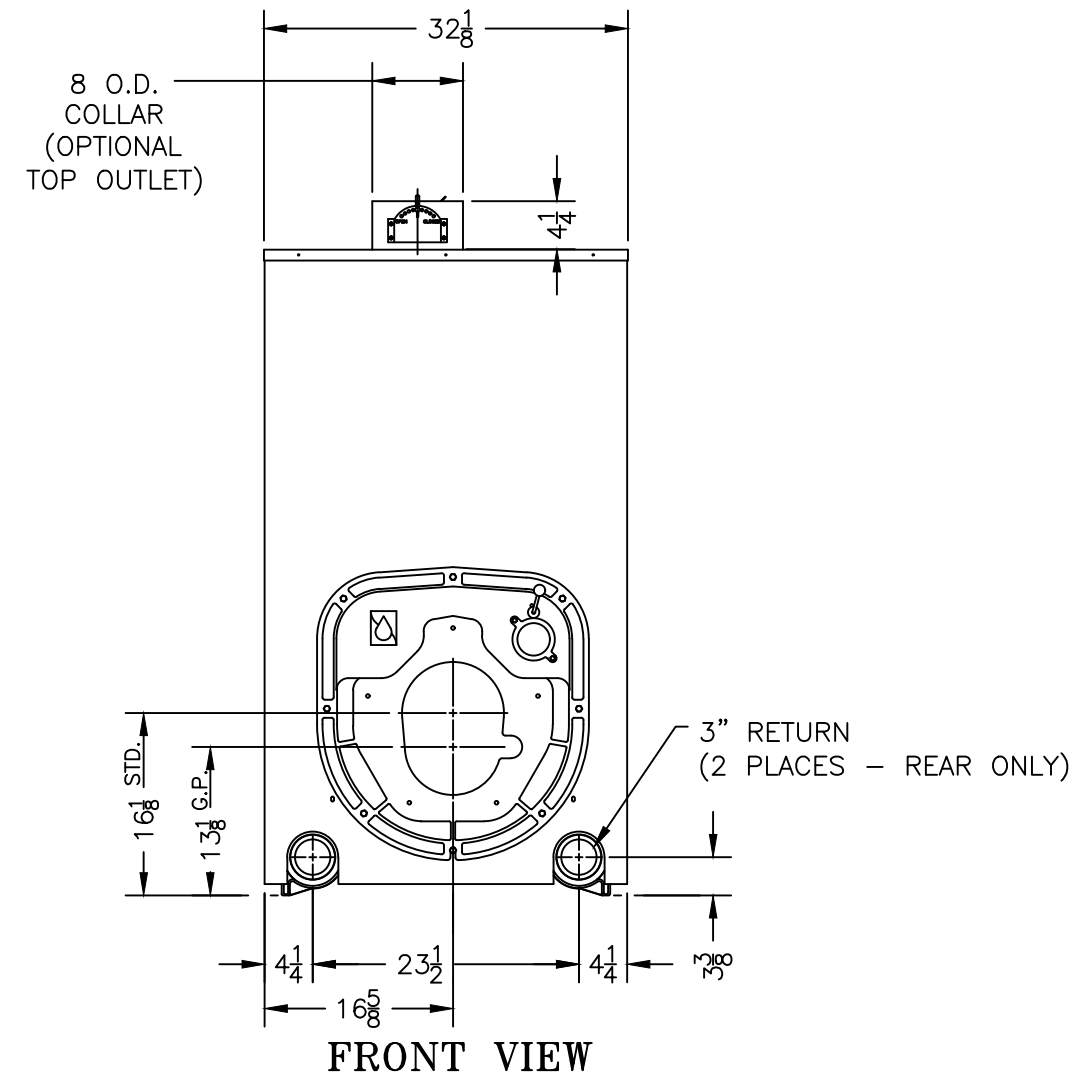

FRONT VIEW

NOTES:

1. TYPICAL POWERFLAME 'C' BURNER LENGTH SHOWN. EXACT BURNER DIMENSIONS MAY VARY.
2. SPECIFICATIONS SUBJECT TO CHANGE WITHOUT NOTICE.

	APPROVED	DRAWN	REV. A2	6/23/22	[FRONT VIEW] 3" RETURN: (2 PLACES - REAR ONLY)
		EJL			(WAS) (4 PLACES). SEE EN. #91-102-15001.
	APPROVED	DRAWN	REV. A	6/14/21	ADDED PACKAGED BASE & BLOCK BASE LAYERS.
		RAR			

DIMENSIONS IN INCHES, FRACTIONAL TOLERANCES $\pm 1/32"$, ANGULAR TOLERANCES $\pm 1^\circ$, UNLESS OTHERWISE NOTED.			SUPERSEDES		DWG. DATE 12/17/08
			DRAWING TITLE		DRAWING NO.
			DIMENSIONAL DRAWING V905A WATER BOILER 20°F OR 40°F TEMPERATURE RISE		TS-91-223-B
DRAWN EAB	CHECKED	DESIGNED	APPROVED RLW	RELEASED	DWG. SCALE 1/16"=1"
					REV. LEVEL A2