

TOP VIEW

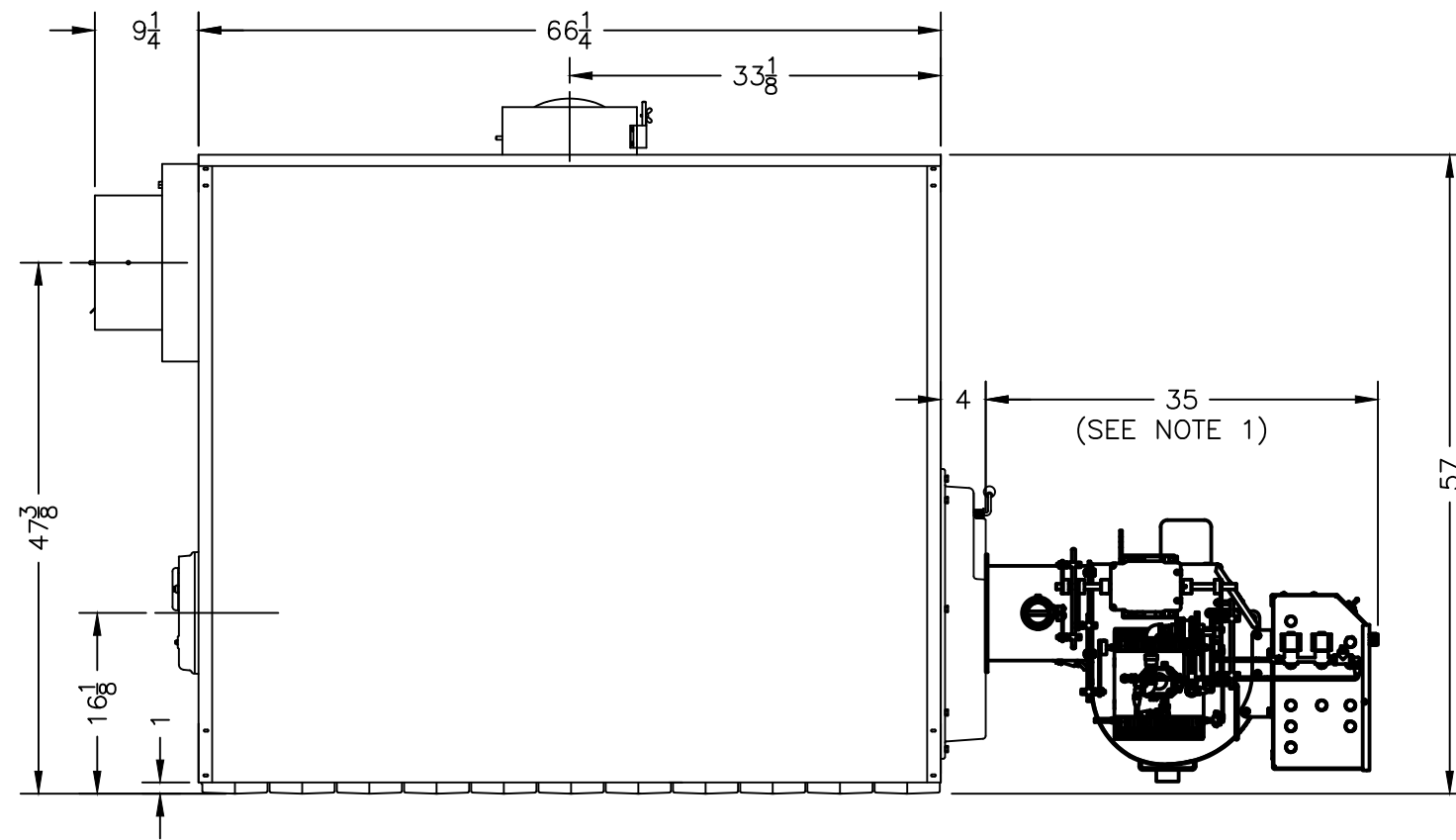

LEFT SIDE VIEW  
(BURNER INSTALLED)

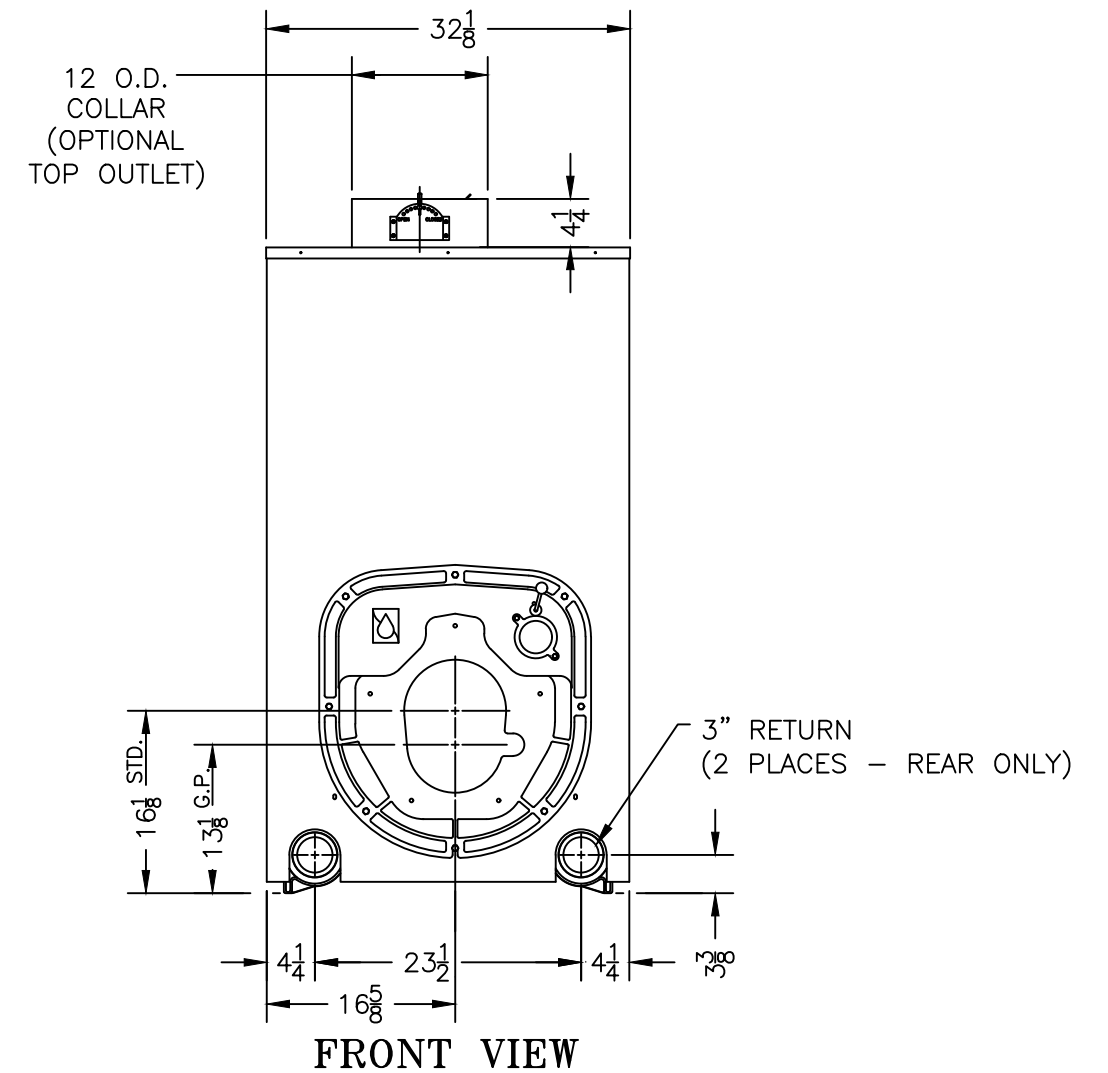

FRONT VIEW

NOTES:

1. TYPICAL POWERFLAME 'C' BURNER LENGTH SHOWN. EXACT BURNER DIMENSIONS MAY VARY.
2. SPECIFICATIONS SUBJECT TO CHANGE WITHOUT NOTICE.

APPROVED	DRAWN	REV. A2	6/23/22	[FRONT VIEW] 3" RETURN: (2 PLACES - REAR ONLY)
	EJL			(WAS) (4 PLACES). SEE EN. #91-102-15001.
APPROVED	DRAWN	REV. A	6/23/21	ADDED PACKAGED BASE & BLOCK BASE LAYERS.
	RAR			

DIMENSIONS IN INCHES, FRACTIONAL TOLERANCES $\pm 1/32"$ , ANGULAR TOLERANCES $\pm 1^\circ$ , UNLESS OTHERWISE NOTED.			SUPERSEDES			DWG. DATE 12/17/08	
			DRAWING TITLE			DRAWING NO.	
			DIMENSIONAL DRAWING V911A WATER BOILER 20°F OR 40°F TEMPERATURE RISE			TS-91-229-B	
DRAWN EAB	CHECKED	DESIGNED	APPROVED RLW	RELEASED	DWG. SCALE 1/16"=1"	REV. LEVEL A2	