

BURNHAM®

Commercial Boilers

RATINGS AND DATA

Shell Diameter : 54"
 Gross Output - BHP : 93.6
 Gross Output - MBH : 3133
 Gross Output - Lbs/Hr : 3230
 Net Rating - MBH : 2433
 Net Rating - Sq. Ft. : 10136
 Safety Valve - Lbs/Hr. : 3600

Heating Surface - Sq. Ft.
 Fireside - 450
 Firetubes
 Number - 106
 Diameter - 2" O.D.

Firing Rate
 1000 BTU Gas (MBH) - 3766
 140000 BTU/Gal Oil (GPH) - 25.9
 150000 BTU/Gal Oil (GPH) - 24.2

Water Content
 Pounds - 4312
 Gallons (U.S.) - 517
 Approximate Weight/LBS.
 Dry - 6400
 Wet - 10712

LEGEND CONNECTIONS

- A = 8" FLANGED SUPPLY (150#)
- B = 3" RETURN
- C = 3" x 4" HANDHOLE
- D = 1" WATER COLUMN
- E = 3/4" AQUASTAT
- F = 1-1/2" BOTTOM BLOWDOWN
- G = 1-1/2" SURFACE BLOWOFF
- H = 1-1/2" AUXILIARY CONNECTION
- J = 2-1/2" SAFETY VALVE
- K = 12" NOMINAL FLUE DIAMETER

LEGEND

- BS = BOTH SIDES
- RS = RIGHT SIDE
- LS = LEFT SIDE

PROJECT: STANDARD BOILER

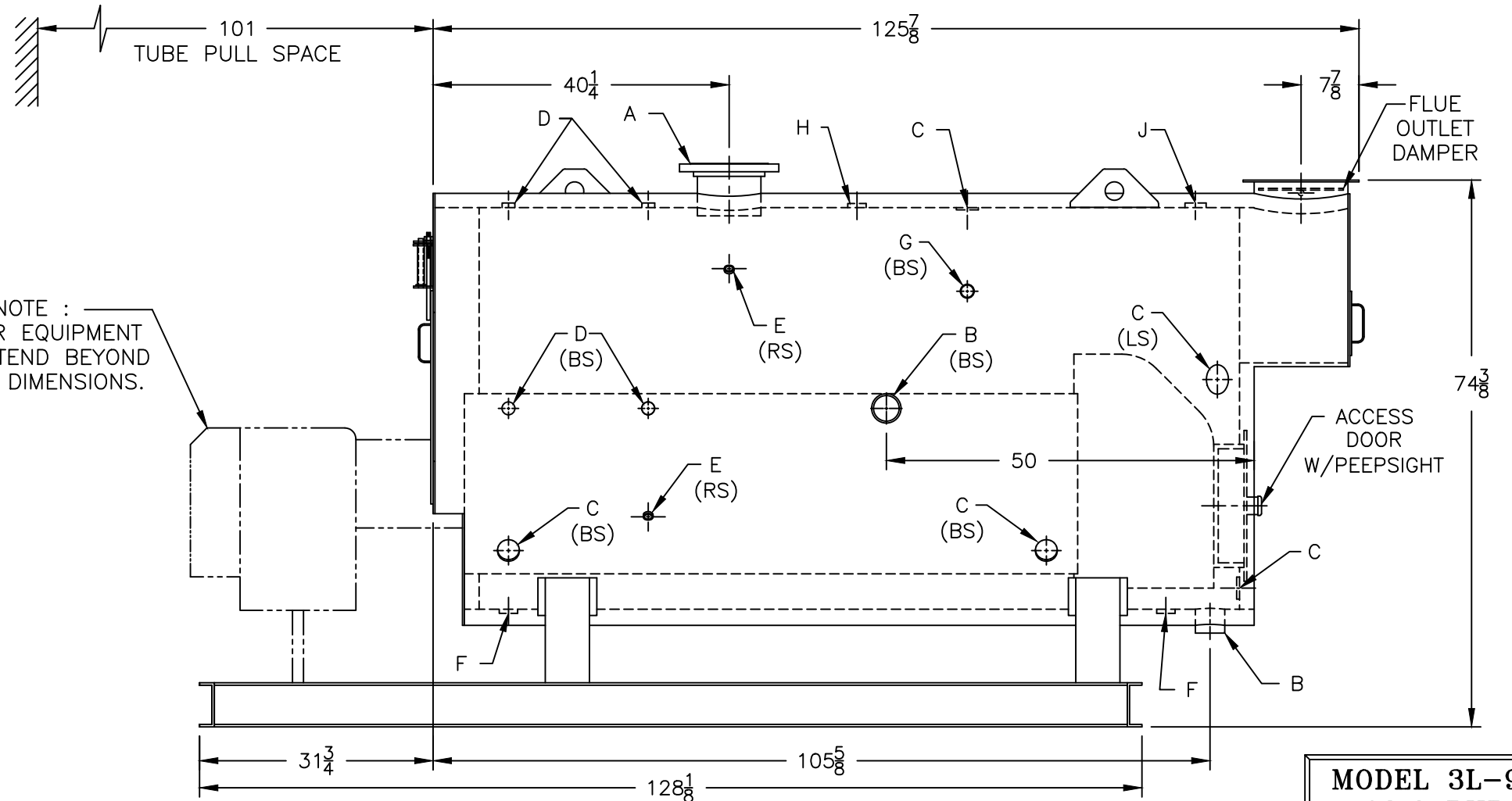
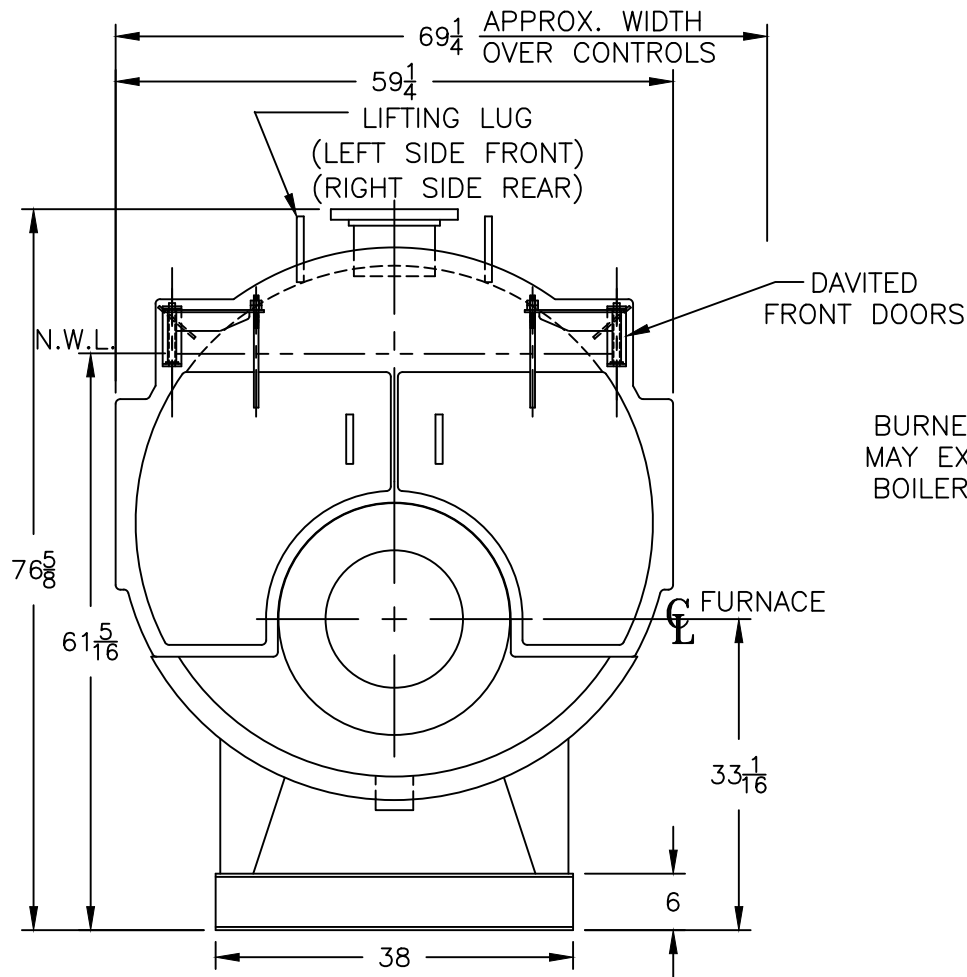
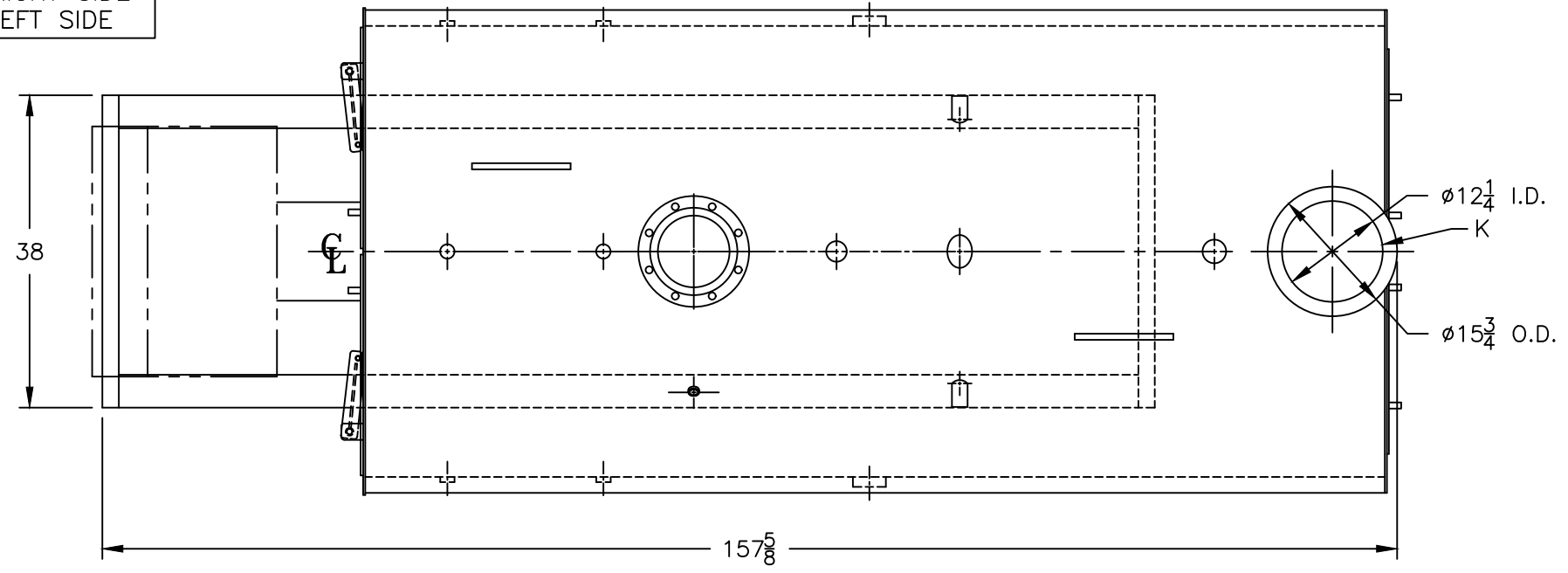

NOTE :
 BURNER EQUIPMENT
 MAY EXTEND BEYOND
 BOILER DIMENSIONS.

MODEL 3L-90
93.6 BHP
15 PSI STEAM

SPECIFICATIONS SUBJECT TO CHANGE WITHOUT NOTICE ALL CONNECTIONS ARE THREADED UNLESS OTHERWISE SPECIFIED

THIS DOCUMENT CONTAINS CONFIDENTIAL INFORMATION WHICH IS THE PROPERTY OF BURNHAM COMMERCIAL. THIS DOCUMENT MAY NOT BE REPRODUCED, TRANSFERRED OR USED, OR ITS CONTENTS DISCLOSED, WITHOUT THE WRITTEN PERMISSION OF THE OWNER.